

Product card KYNAR-GY/50

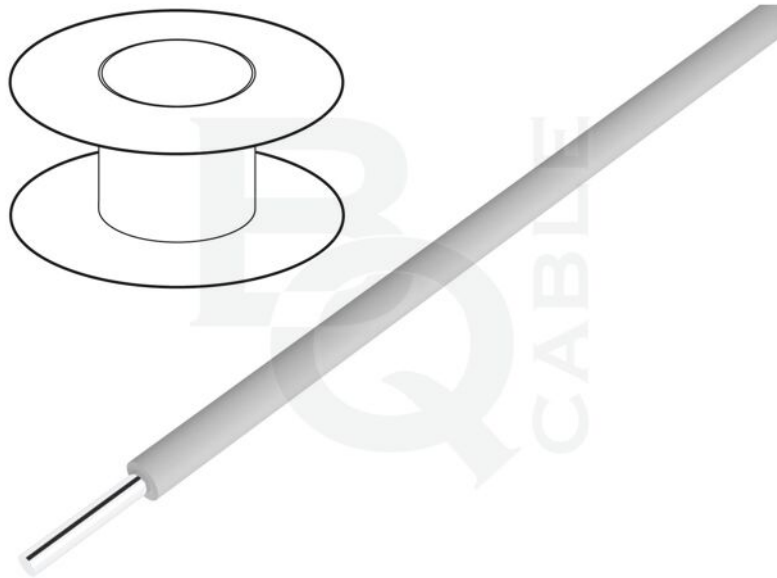

Symbol:	KYNAR-GY/50
Product groups:	Single Core Cables

Product specifications

Type of wire:	assembly
Core diameter:	30AWG
Core structure:	wire
Kind of core:	OFC, silver plated
Number of cores:	1
Wire insulation material:	FEP
Insulation colour:	grey
Rated voltage:	0.25kV
Package contents:	50m

Cable external diameter:	0.56mm
Cable structure:	1x30AWG
Cable application:	for wrapped connections
Operating temperature:	-65...200°C

Additional information

Gross weight:	0.001 kg
----------------------	----------